

SIGNATURE-FIT ORDER FORM

CLIENT INFO

*INFORMATION ON THIS PAGE REQUIRED
ALL OTHERS OPTIONAL.

PO#	DATE
COMPANY NAME	TECHNICIAN NAME
TECHNICIAN PHONE	PATIENT NAME/NUMBER
SEAT FILE NAME	BACK FILE NAME
CHAIR MAKE	CHAIR WIDTH
<input type="radio"/> TRIAL FIT <input type="radio"/> TRIAL FIT W/ LINER & COVERS <input type="radio"/> FINISH CUSHION COMPLETE	SEAT BASE FOAM <input type="radio"/> FIRM (WHITE) <input type="radio"/> SOFT (BLACK)
	BACK BASE FOAM <input type="radio"/> FIRM (WHITE) <input type="radio"/> SOFT (BLACK)



THE POWER OF PRECISION

5325 Kuhl Rd.
Erie, PA 16510
Toll Free 1-866-PRM-REHAB
Phone: 814-899-8731
Fax: 814-899-2934
www.prmrehab.com

Email shapes to:
orders@prmrehab.com

MEASUREMENTS

SEAT TO BACK ANGLE:		MOLDED DIMENSION	INCREASE	DECREASE	FINISHED DIMENSION	
SEAT	SEAT DEPTH	L	+	-		
		R	+	-		
	ADDUCTOR WALL	L	+	-	+	<input type="checkbox"/> MATCH TO RIGHT
		R	+	-	+	<input type="checkbox"/> MATCH TO LEFT
ABDUCTOR		<input type="checkbox"/> AS MOLDED	+	-	+	
FIT	<input type="radio"/> STANDARD FIT <input type="radio"/> LOOSE FIT (1/4" Std.) <input type="radio"/> FOOTREST REMOVAL NOTCHES		<input type="radio"/> SOFT SPOT IT AREA			
MOUNT	<input type="radio"/> ON RAILS <input type="radio"/> BETWEEN RAILS <input type="radio"/> EXTRA-STRONG ADDUCTOR <input type="checkbox"/> Left <input type="checkbox"/> Right <input type="checkbox"/> Both		<input type="radio"/> BEVEL FRONT EDGE			
T-NUT FOR HARDWARE		<input type="radio"/> NONE <input type="radio"/> PRM: <input type="checkbox"/> Full Row <input type="checkbox"/> Partial Row <input type="radio"/> OTHER (specify)			<input type="radio"/> 7/8" <input type="radio"/> 1"	
VELCRO SEAT ATTACHMENT		<input type="radio"/> YES <input type="radio"/> NO <input type="checkbox"/> Left <input type="checkbox"/> Right <input type="checkbox"/> Both				
SEAT TO BACK HEIGHT (to be taken from rear wall of seat to top of back): _____ GAP: _____						
BACK	BACK HEIGHT	MOLDED DIMENSION	+	-	FROM TO (from bottom up)	
	LATERAL DEPTH	L	+	-	<input type="checkbox"/> MATCH TO RIGHT	
		R	+	-	<input type="checkbox"/> MATCH TO LEFT	
	FIT	<input type="radio"/> STANDARD FIT <input type="radio"/> LOOSE FIT (1/4" Std.) <input type="radio"/> EXTRA-STRONG LATERAL <input type="checkbox"/> Left <input type="checkbox"/> Right <input type="checkbox"/> Both				
MOUNT	<input type="radio"/> ON RAILS <input type="radio"/> BETWEEN RAILS <input type="radio"/> BACK SHELL <input type="radio"/> T-NUT FOR SHOULDER STRAPS					
T-NUT FOR HARDWARE		<input type="radio"/> NONE <input type="radio"/> PRM: <input type="checkbox"/> Full Row <input type="checkbox"/> Partial Row <input type="radio"/> OTHER (specify)			<input type="radio"/> 7/8" <input type="radio"/> 1"	
T-NUT FOR HEADREST		<input type="radio"/> NONE <input type="radio"/> PRM <input type="radio"/> OTHER (specify)			<input type="radio"/> ABS BACK (OLD STYLE)	

COVER OPTIONS

<input type="checkbox"/> VACUUM FORMED
<input type="checkbox"/> SLIP Seat Qty _____ Back Qty _____
<input type="checkbox"/> ZIPPERED Seat Qty _____ Back Qty _____
VINYL
<input type="radio"/> GREY
<input type="radio"/> BLACK
<input type="radio"/> BURGUNDY
<input type="radio"/> COBALT
<input type="radio"/> LIGHT WEDGEWOOD
<input type="radio"/> MAUVE
<input type="radio"/> PURPLE GREY
<input type="radio"/> SAGE
NEOPRENE
<input type="radio"/> BLACK
<input type="radio"/> DARK BLUE
<input type="radio"/> GREY
<input type="radio"/> LIGHT BLUE
<input type="radio"/> PURPLE
<input type="radio"/> RED
WATERPROOF LYCRA
<input type="radio"/> BLACK
LYCRA
<input type="radio"/> BLACK
DARTEX*
<input type="radio"/> BLACK
POLARTEC
<input type="radio"/> BLACK
SPACER MESH
<input type="radio"/> BLACK

FOAM LINER

SEAT	BACK	
<input type="radio"/>	<input type="radio"/>	1/4" SOFT
<input type="radio"/>	<input type="radio"/>	1/4" MEDIUM
<input type="radio"/>	<input type="radio"/>	1/4" TOP MEDIUM X 1/2" BOTTOM SOFT
<input type="radio"/>	<input type="radio"/>	1/4" TOP SOFT X 1/2" BOTTOM MEDIUM
<input type="radio"/>	<input type="radio"/>	1/2" SUPER SOFT X 1/2" SUPER SOFT
<input type="radio"/>	<input type="radio"/>	1/2" SUPER SOFT X 1/2" SOFT
<input type="radio"/>	<input type="radio"/>	1/2" TOP SOFT X 1/2" BOTTOM SOFT
<input type="radio"/>	<input type="radio"/>	1/2" TOP MEDIUM X 1/2" BOTTOM MEDIUM
<input type="radio"/>	<input type="radio"/>	1/2" TOP MEDIUM X 1/2" BOTTOM SOFT
<input type="radio"/>	<input type="radio"/>	1/2" TOP SOFT X 1/2" BOTTOM MEDIUM
<input type="radio"/>	<input type="radio"/>	1/2" SOFT
<input type="radio"/>	<input type="radio"/>	1/2" MEDIUM
<input type="radio"/>	<input type="radio"/>	1" SOFT
<input type="radio"/>	<input type="radio"/>	1" SUPER SOFT
<input type="radio"/>	<input type="radio"/>	1/2" SUPER SOFT

COMMENTS

SEAT MODIFICATIONS

BEVELED FRONT EDGE

REINFORCED ABDUCTOR

EXTRA STRONG ADDUCTOR: LEFT RIGHT BOTH

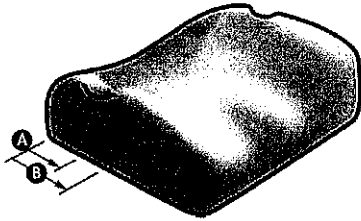

SEAT BELT CUT OUTS

LOCATION FROM REAR OF CUSHION
A: _____
B: _____

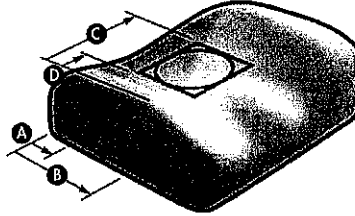

SEAT SOFT SPOT

OVAL
WIDTH: _____ DEPTH: _____
A: _____
B: _____
C: _____
D: _____

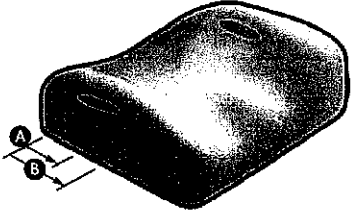

THROUGH THE CUSHION BELT HOLES

LOCATION FROM REAR OF CUSHION
A: _____
B: _____

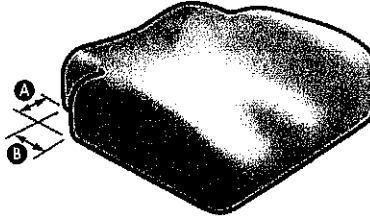

SEAT NOTCHES FOR GROWTH

A: _____
B: _____

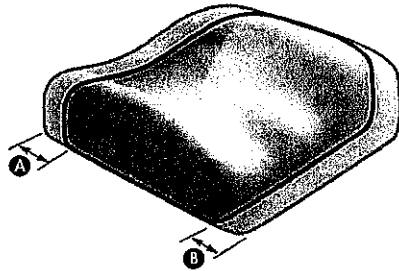

ADD LENGTH FOR GROWTH

A: _____
B: _____

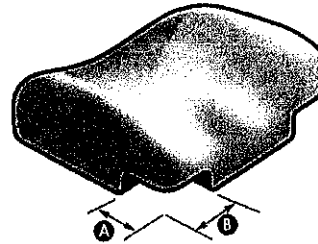

FOOTREST REMOVAL NOTCHES

A: _____
B: _____

SEAT TO BACK JUNCTIONS

STANDARD (1-1/2")

A: _____

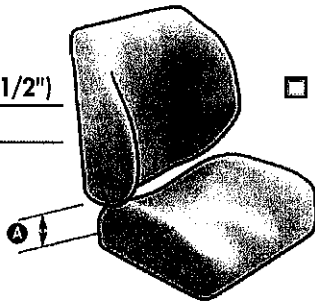

PELVIC CONTROL

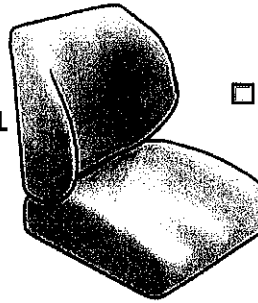

GROWTH

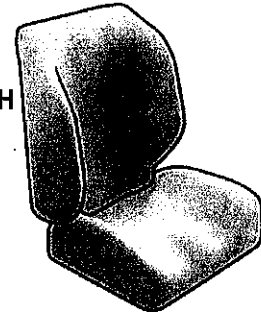

BACK MODIFICATIONS

ROUNDED TOP CORNERS

SWING-AWAY LATERAL LEFT RIGHT BOTH

EXTRA STRONG LATERAL LEFT RIGHT BOTH

BACK SOFT SPOT

OVAL
WIDTH: _____ DEPTH: _____
A: _____
B: _____
C: _____
D: _____

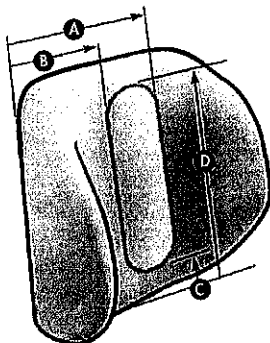

RIB HUMP CONCAVE SHAPE

A: _____
B: _____
C: _____
D: _____
E: _____
F: _____
G: _____

USER'S LEFT USER'S RIGHT

